

Criteria III (Research Publications and Awards)

Key Indicator 3.3- Research Publication and Awards

3.3.2. Number of books and chapters in edited volumes/books published and papers published in national/ international conference proceedings per teacher during last five years

(2019-20)

List of books and chapters in edited volumes/books published
and papers published in national/ international conference
proceedings

AY 2019-20

Sr. No	Name of the Author	Title of the paper / Title of the book/chapters published
1.	Dr. Jayashri Bangali	Electronic Devices and Circuits
		Basics of Applied Electronics
		Semiconductor Devices and Basic Electronic Systems
		Principles of Digital Electronics
		Fundamental of Digital Electronics
		Analog and Digital Device Applications
		Instrumentation Systems
2	Dr. Shweta Bapat	Basics of Computer Organization Paper – II
		Business Demography
3	Ms. Yogeshwari Dannak	Consumer Protection and Business Ethics 1
		Computer Concepts and Application I



PRINCIPAL
Kannada Sangha Pune's
Kaveri College of Arts, Science & Commerce

FIRST YEAR B. Sc.

SEMESTER-I

NEW
SYLLABUS

ELECTRONIC DEVICES AND CIRCUITS

ELECTRONIC SCIENCE : EL-112

CBCS
2 CREDITS



Prof. (Dr.) P. B. BUCHADE
Prof. (Dr.) M. L. DONGARE

S. R. CHAUDHARI
Dr. J. A. BANGALI

 **NIRALI**[®]
PRAKASHAN
ADVANCEMENT OF KNOWLEDGE



PRINCIPAL
Kannada Sangha Purne
Kaveri College of Arts, Science & Commerce

SPPU New Syllabus

A Book Of

ELECTRONIC DEVICES AND CIRCUITS

For
F.Y.B.Sc.

Electronic Science : Paper – II (EL-112) and
As Per New Syllabus of Savitribai Phule Pune University
With Effect from June 2019

Prof. (Dr.) P. B. Buchade

M.Sc., M.Phil., Ph.D.
Principal and Head
Dept. of Electronic Science,
Abasaheb Garware College,
Kamthi Road, Pune - 411004

S. R. Chaudhari

M. Sc., M.Phil.
Vice Principal and Head,
Head, Dept. of Electronic Science,
Modern College, Shivajinagar,
Pune - 411005

Prof. (Dr.) M. L. Dongare

M.Sc., D.K.E., Ph.D.
Head, Dept. of Electronic Science,
Rajawade Shikshan Sanstha's,
S. K. Joshi College,
Wadgaon, Pune - 411028

Dr. J. A. Bangali

M. Sc., M. Phil, Ph.D.
Dept. of Electronic Science,
Kaveri College of Science and Commerce,
Pune - 411038

Price ₹ 70.00

 **NIRALI**
PRAKASHAN
ADVANCEMENT OF KNOWLEDGE

N5011



PRINCIPAL
Kannada Sangha Pune
Kaveri College of Arts, Science & Commerce

F.Y.B.Sc : Electronic Devices and Circuits

First Edition : July 2019

ISBN 978-93-89406-39-9

© : Authors

The text of this publication, or any part thereof, should not be reproduced or transmitted in any form or stored in any computer storage system or device for distribution including photocopy, recording, taping or information retrieval system or reproduced on any disc, tape, perforated media or other information storage device etc., without the written permission of Authors with whom the rights are reserved. Breach of this condition is liable for legal action.

Every effort has been made to avoid errors or omissions in this publication. In spite of this, errors may have crept in. Any mistake, error or discrepancy so noted and shall be brought to our notice shall be taken care of in the next edition. It is notified that neither the publisher nor the authors or seller shall be responsible for any damage or loss of action to any one, of any kind, in any manner, therefrom.

Published By:**NIRALI PRAKASHAN**

Abhyudaya Pragati, 1312, Shivaji Nagar

Off J.M. Road, PUNE – 411005

Tel - (020) 25512336/37/39, Fax - (020) 25511379

Email : niralipune@pragationline.com

Polyplate**Printed By:****RACHANA OFFSETS**

S. No. 15, Arihant Marg

Sukhsagar Nagar, Katraj

Tel - (022) 2778 2011

> DISTRIBUTION CENTRES**PUNE**

Nirali Prakashan : 119, Budhwar Peth, Jogeshwari Mandir Lane, Pune 411002,
(For orders within Pune) Maharashtra, Tel : (020) 2445 2044, Mobile : 9657703145
Email : niralilocal@pragationline.com

Nirali Prakashan : S. No. 28/27, Dhayari, Near Asian College Pune 411041
(For orders outside Pune) Tel : (020) 24690204; Mobile : 9657703143
Email : bookorder@pragationline.com

MUMBAI

Nirali Prakashan : 385, S.V.P. Road, Rasdhara Co-op. Hsg. Society Ltd.,
Girgaum, Mumbai 400004, Maharashtra;
Mobile : 9320129587 Tel : (022) 2385 6339 / 2386 9976,
Fax : (022) 2386 9976
Email : niralimumbai@pragationline.com

> DISTRIBUTION BRANCHES**JALGAON**

Nirali Prakashan : 34, V. V. Golani Market, Navi Peth, Jalgaon 425001,
Maharashtra, Tel : (0257) 222 0395, Mob : 94234 91860;
Email : niralijalgaon@pragationline.com

KOLHAPUR

Nirali Prakashan : New Mahadvar Road, Kedar Plaza, 1st Floor Opp. IDBI Bank,
Kolhapur 416 012, Maharashtra. Mob : 9850046155;
Email : niralikolhapur@pragationline.com

NAGPUR

Nirali Prakashan : Above Maratha Mandir, Shop No. 3, First Floor,
Rani Jhanshi Square, Sitabuldi, Nagpur 440012, Maharashtra
Tel : (0712) 254 7129;
Email : niralinagpur@pragationline.com

DELHI

Nirali Prakashan : 4593/15, Basement, Agarwal Lane, Ansari Road, Daryaganj
Near Times of India Building, New Delhi - 110002
Mob : 08505972553, Email : niralidelhi@pragationline.com

BENGALURU

Nirali Prakashan : Maitri Ground Floor, Jaya Apartments, No. 99, 6th Cross,
6th Main, Malleswaram, Bengaluru 560003, Karnataka;
Mob : 9449043034
Email : niralibangalore@pragationline.com

Other Branches : Hyderabad, Chennainiralipune@pragationline.com | www.pragationline.comAlso find us on  www.facebook.com/niralibooks**PRINCIPAL**Kannada Sangha Pune's
Kaveri College of Arts, Science & Commerce

SALIENT FEATURES OF THE BOOK

- Widely recommended Text book for F.Y. B.Sc.: Semester-I
- According to New Syllabus CBCS Pattern (Credit 2) of Savitribai Phule Pune University.
- This book is written in simple and lucid language and highlighted by diagrams so that the contents are easy to understand and remember for the students.
- It focuses on clarity of the fundamental concepts and explains them according to the need of students.
- Each chapter ends with related questions for discussion and points to remember, which helps students to recapitulate all that has been learned in the particular chapter.
- The explanation of each topic is supported by figures, graphics, charts and tables.
- Each topic and sub-topic is further illustrated with suitable examples.
- Overall this book is authored by highly qualified and experienced teachers of SPPU representing BOS, AC, University Dept. and well known Colleges.

BOOKS AVAILABLE AT

PRAGATI BOOK CENTER - Email: pbcpune@pragationline.com

- 157 Budhwar Peth, Opp. Ratan Talkies, Next To Balaji Mandir, Pune 411002 • Mobile : 9657703148
- 676/B Budhwar Peth, Opp. Jogeshwari Mandir, Pune 411002
Tel : (020) 2448 7459 • Mobile : 9657703147 / 9657703149
- 152 Budhwar Peth, Near Jogeshwari Mandir, Pune 411002
Mobile : 8087881795
- 28/A Budhwar Peth, Amber Chambers, Appa Balwant Chowk, Pune 411002 • Tel : (020) 6628 1669 • Mobile : 9657703142

PRAGATI BOOK CORNER - Email: niralimumbai@pragationline.com

- Indira Niwas, 111 - A, Bhavani Shankar Road, Dadar (W), Mumbai 400028. • Tel: (022) 2422 3526/6662 5254

niralipune@pragationline.com | www.pragationline.com

Also find us on



www.facebook.com/niralibooks



@nirali.prakashan



PRINCIPAL
Kannada Sangha Pune
Kaveri College of Arts, Science & Commerce

FIRST YEAR B. Sc.

SEMESTER-I

NEW
SYLLABUS

BASICS OF APPLIED ELECTRONICS

ELECTRONIC SCIENCE : EL-111

CBCS
2 CREDITS

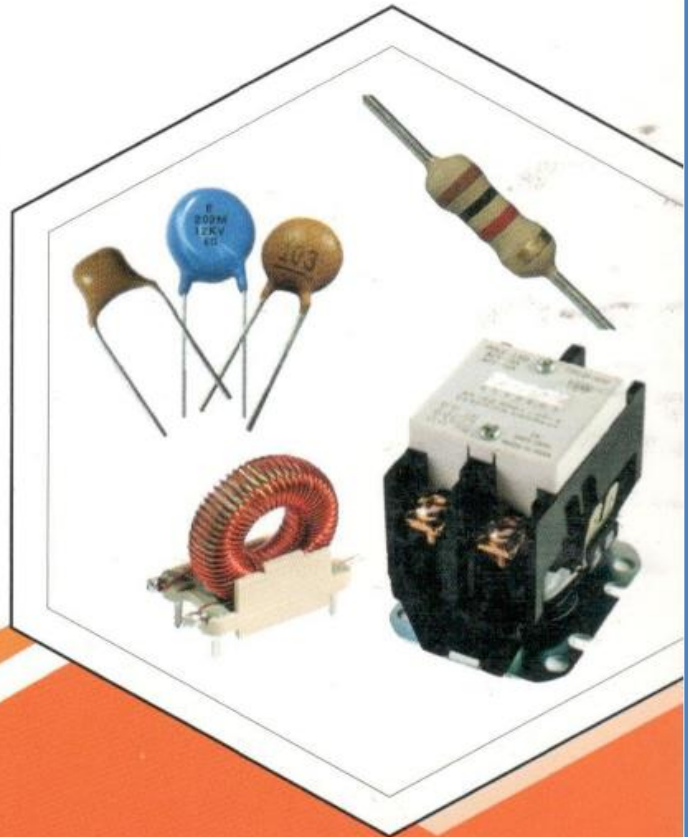

S. R. CHAUDHARI
Dr. J. A. BANGALI

Prof. (Dr.) P. B. BUCHADE
Prof. (Dr.) M. L. DONGARE

 **NIRALI**
PRAKASHAN
ADVANCEMENT OF KNOWLEDGE



PRINCIPAL
Kannada Sangha Pune's
Kaveri College of Arts, Science & Commerce

SPPU New Syllabus

A Book Of

BASICS OF APPLIED ELECTRONICS

For

F.Y.B.Sc.

Electronic Science : Paper – I (EL-111)

As Per New Syllabus of Savitribai Phule

Pune University With Effect from June 2019

S. R. Chaudhari

M. Sc., M.Phil.
Vice Principal and Head,
Dept. of Electronic Science,
Modern College, Shivajinagar,
Pune – 411005.

Prof. (Dr.) P. B. Buchade

M.Sc., M.Phil., Ph.D.
Principal and Head
Dept. of Electronic Science,
Abasaheb Garware College,
Karve Road, Pune - 411004.

Dr. J. A. Bangali

M. Sc., M. Phil., Ph.D.
Head, Dept. of Electronic Science,
Waver College of Science and Commerce,
Pune – 411038.

Prof. (Dr.) M. L. Dongare

M.Sc., D.H.E., Ph.D.
Head, Dept. of Electronic Science,
Rayat Shikshan Sanstha's,
S. M. Joshi College,
Hadapsar, Pune – 411028.

Price ₹ 75.00

 **NIRALI**
PRAKASHAN
ADVANCEMENT OF KNOWLEDGE

N5010



PRINCIPAL

Kannada Sangha Pune
Kaveri College of Arts, Science & Commerce

F.Y.B.Sc : Basics of Applied Electronics ISBN 978-93-89406-40-5

First Edition : July 2019

© : **Authors**

The text of this publication, or any part thereof, should not be reproduced or transmitted in any form or stored in any computer storage system or device for distribution including photocopy, recording, taping or information retrieval system or reproduced on any disc, tape, perforated media or other information storage device etc., without the written permission of Authors with whom the rights are reserved. Breach of this condition is liable for legal action.

Every effort has been made to avoid errors or omissions in this publication. In spite of this, errors may have crept in. Any mistake, error or discrepancy so noted and shall be brought to our notice shall be taken care of in the next edition. It is notified that neither the publisher nor the authors or seller shall be responsible for any damage or loss of action to any one, of any kind, in any manner, therefrom.

Published By:
NIRALI PRAKASHAN

Abhyudaya Pragati, 1312, Shivaji Nagar
Off J.M. Road, PUNE - 411005
Tel - (020)-25512336/37/39, Fax - (020) 25511379
Email : niralipune@pragationline.com

Polyplate

Printed By:
RACHANA OFFSETS

S. No. 15, Arihant Marg
Sukhsagar Nagar, Katraj
Tel - (022) 2778 2011

➤ **DISTRIBUTION CENTRES**

PUNE

Nirali Prakashan : 119, Budhwar Peth, Jogeshwari Mandir Lane, Pune 411002,
(For orders within Pune) Maharashtra, Tel : (020) 2445 2044, Mobile : 9657703145
Email : niralilocal@pragationline.com

Nirali Prakashan : S. No. 28/27, Dhayari, Near Asian College Pune 411041
(For orders outside Pune) Tel : (020) 24690204; Mobile : 9657703143
Email : bookorder@pragationline.com

MUMBAI

Nirali Prakashan : 385, S.V.P. Road, Rasdhara Co-op. Hsg. Society Ltd.,
Girgaum, Mumbai 400004, Maharashtra;
Mobile : 9320129587 Tel : (022) 2385 6339 / 2386 9976,
Fax : (022) 2386 9976
Email : niralimumbai@pragationline.com

➤ **DISTRIBUTION BRANCHES**

JALGAON

Nirali Prakashan : 34, V. V. Golani Market, Navi Peth, Jalgaon 425001,
Maharashtra, Tel : (0257) 222 0395, Mob : 94234 91860;
Email : niralijalgaon@pragationline.com

KOLHAPUR

Nirali Prakashan : New Mahadvar Road, Kedar Plaza, 1st Floor Opp. IDBI Bank,
Kolhapur 416 012, Maharashtra. Mob : 9850046155;
Email : niralikolhapur@pragationline.com

NAGPUR

Nirali Prakashan : Above Maratha Mandir, Shop No. 3, First Floor,
Rani Jhanshi Square, Sitabuldi, Nagpur 440012, Maharashtra
Tel : (0712) 254 7129;
Email : niralinagpur@pragationline.com

DELHI

Nirali Prakashan : 4593/15, Basement, Agarwal Lane, Ansari Road, Daryaganj
Near Times of India Building, New Delhi 110002
Mob : 08505972553, Email : niralidelhi@pragationline.com

BENGALURU

Nirali Prakashan : Maitri Ground Floor, Jaya Apartments, No. 99, 6th Cross,
6th Main, Malleswaram, Bengaluru 560003, Karnataka;
Mob : 9449043034
Email: niralibangalore@pragationline.com

Other Branches : Hyderabad, Chennai

niralipune@pragationline.com | www.pragationline.com

Also find us on  www.facebook.com/niralibooks



Principals
PRINCIPAL
Kannada Sangha Pune
Kaveri College of Arts, Science & Commerce

SALIENT FEATURES OF THE BOOK

- Widely recommended Text book for F.Y. B.Sc.: Semester-I
- According to New Syllabus CBCS Pattern (Credit 2) of Savitribai Phule Pune University.
- This book is written in simple and lucid language and highlighted by diagrams so that the contents are easy to understand and remember for the students.
- It focuses on clarity of the fundamental concepts and explains them according to the need of students.
- Each chapter ends with related questions for discussion and points to remember, which helps students to recapitulate all that has been learned in the particular chapter.
- The explanation of each topic is supported by figures, graphics, charts and tables.
- Each topic and sub-topic is further illustrated with suitable examples.
- Overall this book is authored by highly qualified and experienced teachers of SPPU representing BOS, AC, University Dept. and well known Colleges.

BOOKS AVAILABLE AT

PRAGATI BOOK CENTER - Email: pbcpune@pragationline.com

- 157 Budhwar Peth, Opp. Ratan Talkies, Next To Balaji Mandir, Pune 411002 • **Mobile** : 9657703148
- 676/B Budhwar Peth, Opp. Jogeshwari Mandir, Pune 411002
Tel : (020) 2448 7459 • **Mobile** : 9657703147 / 9657703149
- 152 Budhwar Peth, Near Jogeshwari Mandir, Pune 411002
Mobile : 8087881795
- 28/A Budhwar Peth, Amber Chambers, Appa Balwant Chowk, Pune 411002 • **Tel** : (020) 6628 1669 • **Mobile** : 9657703142

PRAGATI BOOK CORNER - Email: niralimumbai@pragationline.com

- Indira Niwas, 111 - A, Bhavani Shankar Road, Dadar (W), Mumbai 400028. • **Tel**: (022) 2422 3526/6662 5254

niralipune@pragationline.com | www.pragationline.com

Also find us on



www.facebook.com/niralibooks



[@nirali.prakashan](https://www.instagram.com/nirali.prakashan)



[Signature]
PRINCIPAL
Kannada Sangha Pune's
Kaveri College of Arts, Science & Commerce

FIRST YEAR B. Sc.
COMPUTER SCIENCE

SEMESTER-I

NEW
SYLLABUS

SEMICONDUCTOR DEVICES AND BASIC ELECTRONIC SYSTEMS

Electronics : ELC-111

CBCS
2 CREDITS

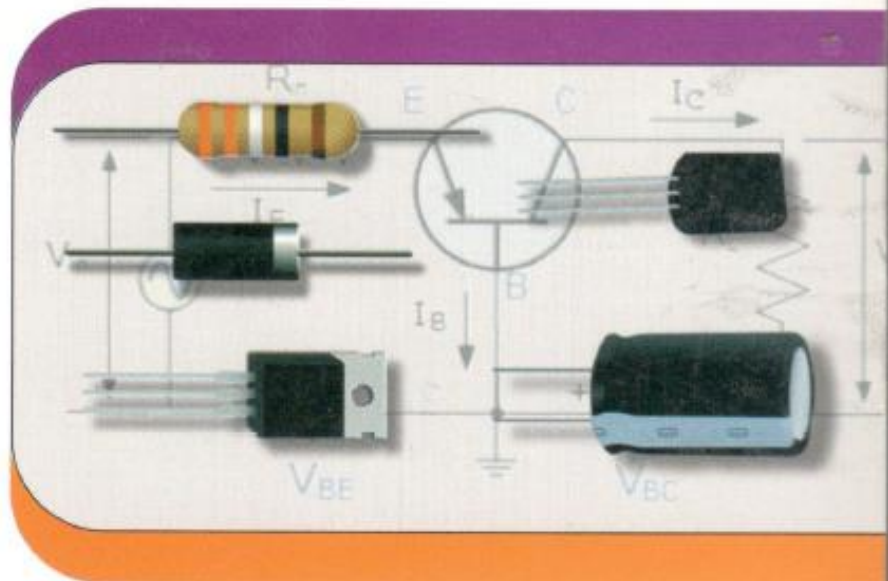

Dr. J. A. BANGALI
Dr. P. B. BUCHADE

Dr. M. L. DONGARE
S. R. CHAUDHARI

NIRALI
PRAKASHAN
ADVANCEMENT OF KNOWLEDGE



[Signature]
PRINCIPAL
Kannada Sangha Pune
Kavari College of Arts, Science & Commerce

SPPU New Syllabus

A Book Of

SEMICONDUCTOR DEVICES AND BASIC ELECTRONIC SYSTEMS

For

F.Y.B.Sc.

**Electronics Subject of Computer Science : Paper – I (ELC-111)
As Per New Revised Syllabus of Savitribai Phule
Pune University With Effect from June 2019**

Dr. J. A. Bangali

M. Sc., M. Phil., Ph.D.
Head, Dept. of Electronic Science,
Kaveri College of Science and Commerce,
Pune - 411038

Prof. M. L. Dongare

M.Sc., D.H.E., Ph.D.
Head, Dept. of Electronic Science,
Rayat Shikshan Sanstha's,
S. M. Joshi College,
Hadapsar, Pune - 411028

Prof. P. B. Buchade

M.Sc., M.Phil., Ph.D.
Principal and Head
Dept. of Electronic Science,
Abasaheb Garware College,
Karve Road, Pune - 411004

S. R. Chaudhari

M. Sc., M.Phil.
Vice Principal and Head,
Dept. of Electronic Science,
Modern College, Shivajinagar,
Pune - 411005.

Price ₹ 80.00

 **NIRALI**
PRAKASHAN
ADVANCEMENT OF KNOWLEDGE

N5052



PRINCIPAL

Kannada Sangha Pune
Kaveri College of Arts, Science & Commerce

F.Y.B.Sc : Semiconductor Devices and Basic Electronic Systems

First Edition : July 2019

ISBN 978-93-83073-82-5

© : Authors

The text of this publication, or any part thereof, should not be reproduced or transmitted in any form or stored in any computer storage system or device for distribution including photocopy, recording, taping or information retrieval system or reproduced on any disc, tape, perforated media or other information storage device etc., without the written permission of Authors with whom the rights are reserved. Breach of this condition is liable for legal action.

Every effort has been made to avoid errors or omissions in this publication. In spite of this, errors may have crept in. Any mistake, error or discrepancy so noted and shall be brought to our notice shall be taken care of in the next edition. It is notified that neither the publisher nor the authors or seller shall be responsible for any damage or loss of action to any one, of any kind, in any manner, therefrom.

Published By:**NIRALI PRAKASHAN**

Abh. Yudaya Pragati, 1312, Shivaji Nagar

Off J.M. Road, PUNE - 411005

Tel - (020) 25512336/37/39, Fax - (020) 25511379

Email : niralipune@pragationline.com

Polyplate**Printed By:****RACHANA OFFSETS**

S. No. 15, Arihant Marg

Sukhsagar Nagar, Katraj

Tel - (022) 2778 2011

> DISTRIBUTION CENTRES**PUNE**

Nirali Prakashan : 119, Budhwar Peth, Jogeshwari Mandir Lane, Pune 411002, Maharashtra, Tel : (020) 2445 2044, Mobile : 9657703145
(For orders within Pune) Email : niralilocal@pragationline.com

Nirali Prakashan : S. No. 28/27, Dhayari, Near Asian College Pune 411041
(For orders outside Pune) Tel : (020) 24690204; Mobile : 9657703143
Email : bookorder@pragationline.com

MUMBAI

Nirali Prakashan : 385, S.V.P. Road, Rasdhara Co-op. Hsg. Society Ltd.,
Girgaum, Mumbai 400004, Maharashtra;
Mobile : 9320129587 Tel : (022) 2385 6339 / 2386 9976,
Fax : (022) 2386 9976
Email : niralimumbai@pragationline.com

> DISTRIBUTION BRANCHES**JALGAON**

Nirali Prakashan : 34, V. V. Golani Market, Navi Peth, Jalgaon 425001,
Maharashtra, Tel : (0257) 222 0395, Mob : 94234 91860;
Email : niralijalgaon@pragationline.com

KOLHAPUR

Nirali Prakashan : New Mahadvar Road, Kedar Plaza, 1st Floor Opp. IDBI Bank,
Kolhapur 416 012, Maharashtra. Mob : 9850046155;
Email : niralikolhapur@pragationline.com

NAGPUR

Nirali Prakashan : Above Maratha Mandir, Shop No. 3, First Floor,
Rani Jhanshi Square, Sitabuldi, Nagpur 440012, Maharashtra
Tel : (0712) 254 7129;
Email : niralinagpur@pragationline.com

DELHI

Nirali Prakashan : 4593/15, Basement, Agarwal Lane, Ansari Road, Daryaganj
Near Times of India Building, New Delhi 110002
Mob : 08505972553, Email : niralidelhi@pragationline.com

BENGALURU

Nirali Prakashan : Maitri Ground Floor, Jaya Apartments, No. 99, 6th Cross,
6th Main, Malleswaram, Bengaluru 560003, Karnataka;
Mob : 9449043034
Email: niralibangalore@pragationline.com

Other Branches : Hyderabad, Chennai**niralipune@pragationline.com | www.pragationline.com****Also find us on  www.facebook.com/niralibooks****PRINCIPAL**

Kannada Sangha Pune's

Kannada College of Arts, Science & Commerce

SALIENT FEATURES OF THE BOOK

- Widely recommended Text book for F.Y. B. Sc. Computer Science: Semester-I
- According to New Syllabus CBCS Pattern (2 Credits) of Savitribai Phule Pune University.
- This book is written in simple and lucid language, so that the contents are easy to understand.
- It focuses on clarity of the fundamental concepts and explains them according to the need of students.
- Each chapter ends with related questions for discussion, points to remember, MCQs and previous University questions, which helps students recapitulate all that has been covered in the chapter.
- The content of each topic is supported by figures, graphics, charts and tables.
- Each topic and sub topic is further illustrated with numerous solved examples.

BOOKS AVAILABLE AT

PRAGATI BOOK CENTER - Email: pbcpune@pragationline.com

- 157 Budhwar Peth, Opp. Ratan Talkies, Next To Balaji Mandir, Pune 411002 • **Mobile** : 9657703148
- 676/B Budhwar Peth, Opp. Jogeshwari Mandir, Pune 411002
Tel : (020) 2448 7459 • **Mobile** : 9657703147 / 9657703149
- 152 Budhwar Peth, Near Jogeshwari Mandir, Pune 411002
Mobile : 8087881795
- 28/A Budhwar Peth, Amber Chambers, Appa Balwant Chowk, Pune 411002 • **Tel** : (020) 6628 1669 • **Mobile** : 9657703142

PRAGATI BOOK CORNER - Email: niralimumbai@pragationline.com

- Indira Niwas, 111 - A, Bhavani Shankar Road, Dadar (W), Mumbai 400028. • **Tel**: (022) 2422 3526/6662 5254

niralipune@pragationline.com | www.pragationline.com

Also find us on



www.facebook.com/niralibooks



[@nirali.prakashan](https://www.instagram.com/nirali.prakashan)

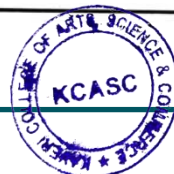

PRINCIPAL

Kannada Sangha Pune
Kaveri College of Arts, Science & Commerce

FIRST YEAR B. Sc.
COMPUTER SCIENCE

SEMESTER-I

NEW
SYLLABUS

PRINCIPLES OF DIGITAL ELECTRONICS

Electronics : ELC-112

CBCS
2 CREDITS

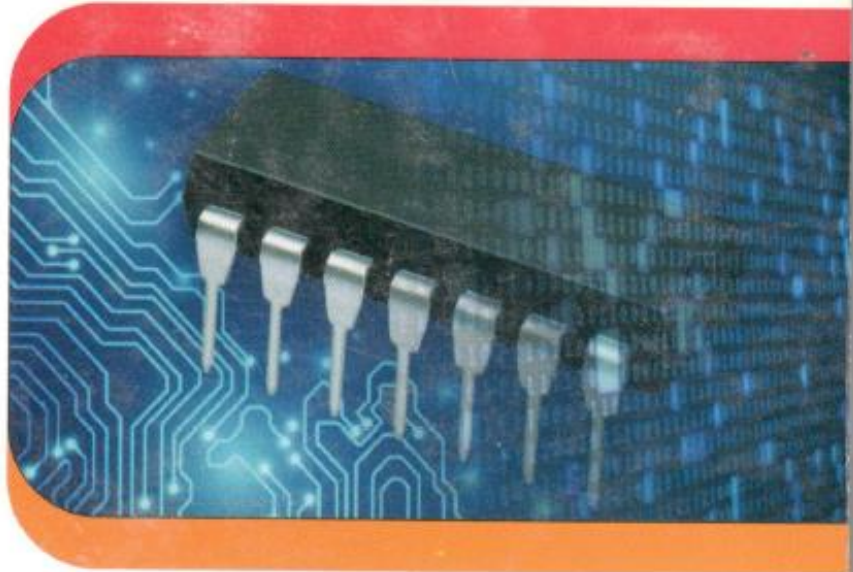

Dr. M. L. DONGARE
S. R. CHAUDHARI

Dr. J. A. BANGALI
Dr. P. B. BUCHADE

 **NIRALI**
PRAKASHAN
ADVANCEMENT OF KNOWLEDGE



PRINCIPAL
Kannada Sangha Pune
Kannara College of Arts, Science & Commerce

Dr. Jayashri Bangali

SPPU New Syllabus

A Book Of

PRINCIPLES OF DIGITAL ELECTRONICS

For
F.Y.B.Sc.

Electronics Subject of Computer Science : Paper – II (ELC-112)
As Per New Revised Syllabus of Savitribai Phule Pune University
With Effect from June 2019

Prof. (Dr.) M. L. Dongare

M.Sc., D.H.E., Ph.D.
Head, Dept. of Electronic Science,
Rayat Shikshan Sanstha's,
S. M. Joshi College,
Hadapsar, Pune - 411028

Dr. J. A. Bangali

M. Sc., M. Phil, Ph.D.
Head, Dept. of Electronic Science,
Kaveri College of Science and Commerce,
Pune - 411038

S. R. Chaudhari

M. Sc., M.Phil.
Vice Principal and Head,
Dept. of Electronic Science,
Modern College, Shivajinagar,
Pune - 411005.

Prof. (Dr.) P. B. Buchade

M.Sc., M.Phil., Ph.D.
Principal and Head
Dept. of Electronic Science,
Abasaheb Garware College,
Karve Road, Pune - 411004

Price ₹ 80.00

 **NIRALI**
PRAKASHAN
ADVANCEMENT OF KNOWLEDGE

N5053



PRINCIPAL

Kannada Sangha Pune's

Kaveri College of Arts, Science & Commerce

F.Y.B.Sc : Principles of Digital Electronics (P-II)

First Edition : July 2013

ISBN 978-93-83073-83-2

© : Authors

The text of this publication, or any part thereof, should not be reproduced or transmitted in any form or stored in any computer storage system or device for distribution including photocopy, recording, taping or information retrieval system or reproduced on any disc, tape, perforated media or other information storage device etc., without the written permission of Authors with whom the rights are reserved. Breach of this condition is liable for legal action.

Every effort has been made to avoid errors or omissions in this publication. In spite of this, errors may have crept in. Any mistake, error or discrepancy so noted and shall be brought to our notice shall be taken care of in the next edition. It is notified that neither the publisher nor the authors or seller shall be responsible for any damage or loss of action to any one, of any kind, in any manner, therefrom.

Published By:

NIPALI PRAKASHAN

Abhyudaya Pragati, 1312, Shivaji Nagar
Off J.M. Road, PUNE - 411005
Tel - (020) 25512336/37/39, Fax - (020) 25511379
Email : niralipune@pragationline.com

Polyplate

Printed By:

RACHANA OFFSETS

S. No. 15, Arihant Marg
Sukhsagar Nagar, Katraj
Tel - (022) 2778 2011

➤ **DISTRIBUTION CENTRES**

PUNE

Nirali Prakashan : 119, Budhwar Peth, Jogeshwari Mandir Lane, Pune 411002,
(For orders within Pune) Maharashtra, Tel : (020) 2445 2044, Mobile : 9657703145
Email : niralilocal@pragationline.com

Nirali Prakashan : S. No. 28/27, Dhayari, Near Asian College Pune 411041
(For orders outside Pune) Tel : (020) 24690204; Mobile : 9657703143
Email : bookorder@pragationline.com

MUMBAI

Nirali Prakashan : 385, S.V.P. Road, Rasdhara Co-op. Hsg. Society Ltd.,
Girgaum, Mumbai 400004, Maharashtra;
Mobile : 9320129587 Tel : (022) 2385 6339 / 2386 9976,
Fax : (022) 2386 9976
Email : niralimumbai@pragationline.com

➤ **DISTRIBUTION BRANCHES**

JALGAON

Nirali Prakashan : 34, V. V. Golani Market, Navi Peth, Jalgaon 425001,
Maharashtra, Tel : (0257) 222 0395, Mob : 94234 91860;
Email : niralijalgaon@pragationline.com

KOLHAPUR

Nirali Prakashan : New Mahadvar Road, Kedar Plaza, 1st Floor Opp. IDBI Bank,
Kolhapur 416 012, Maharashtra. Mob : 9850046155;
Email : niralikolhapur@pragationline.com

NAGPUR

Nirali Prakashan : Above Maratha Mandir, Shop No. 3, First Floor,
Rani Jhanshi Square, Sitabuldi, Nagpur 440012, Maharashtra
Tel : (0712) 254 7129;
Email : niralinagpur@pragationline.com

DELHI

Nirali Prakashan : 4593/15, Basement, Agarwal Lane, Ansari Road, Daryaganj
Near Times of India Building, New Delhi 110002
Mob : 08525972553, Email : niralidelhi@pragationline.com

BENGALURU

Nirali Prakashan : Maitri Ground Floor, Jaya Apartments, No. 99, 6th Cross,
6th Main, Malleswaram, Bengaluru 560003, Karnataka;
Mob : 9449043134
Email : niralibangalore@pragationline.com

Other Branches: Hyderabad, Chennai

niralipune@pragationline.com | www.pragationline.com

Also find us on www.facebook.com/niralifbooks



PRINCIPAL

Kannada Sangha Pune's
Kaveri College of Arts, Science & Commerce

SALIENT FEATURES OF THE BOOK

- Widely recommended Text book for F.Y. B. Sc. Computer Science: Semester-I
- According to New Syllabus CBCS Pattern (2 Credits) of Savitribai Phule Pune University.
- This book is written in simple and lucid language, so that the contents are easy to understand.
- It focuses on clarity of the fundamental concepts and explains them according to the need of students.
- Each chapter ends with related questions for discussion, points to remember, MCQs and previous University questions, which helps students recapitulate all that has been covered in the chapter.
- The content of each topic is supported by figures, graphics, charts and tables.
- Each topic and sub topic is further illustrated with numerous solved examples.

BOOKS AVAILABLE AT

PRAGATI BOOK CENTER - Email: pbcpune@pragationline.com

- 157 Budhwar Peth, Opp. Ratan Talkies, Next To Balaji Mandir, Pune 411002 • **Mobile** : 9657703148
- 676/B Budhwar Peth, Opp. Jogeshwari Mandir, Pune 411002
Tel : (020) 2448 7459 • **Mobile** : 9657703147 / 9657703149
- 152 Budhwar Peth, Near Jogeshwari Mandir, Pune 411002
Mobile : 8087881795
- 28/A Budhwar Peth, Amber Chambers, Appa Balwant Chowk, Pune 411002 • **Tel** : (020) 6628 1669 • **Mobile** : 9657703142

PRAGATI BOOK CORNER - Email: niralimumbai@pragationline.com

- Indira Niwas, 111 - A, Bhavani Shankar Road, Dadar (W), Mumbai 400028. • **Tel**: (022) 2422 3526/6662 5254

niralipune@pragationline.com | www.pragationline.com

Also find us on



www.facebook.com/niralibooks



@nirali.prakashan



PRINCIPAL

Kannada Sangha Pune's
Kaveri College of Arts, Science & Commerce

FIRST YEAR B. Sc.

SEMESTER-II

NEW
SYLLABUS

FUNDAMENTALS OF DIGITAL ELECTRONICS

CBCS
2 CREDITS

Electronics (EL-121) : Paper-I

Prof. P. B. BUCHADE
Dr. J. A. BANGALI

Prof. M. L. DONGARE
S. R. CHAUDHARI



 **NIRALI**
PRAKASHAN
ADVANCEMENT OF KNOWLEDGE



PRINCIPAL
Kannada Sangha Pune's
Kaveri College of Arts, Science & Commerce

Dr. Jayashri Bangali

SPPU New Syllabus

EL-121

FUNDAMENTALS OF DIGITAL ELECTRONICS

[2 Credits]

Electronic Science : Paper-I

For

First Year B.Sc. Semester-II

As Per New Syllabus of CBCS Pattern

From June - 2019

Prof. (Dr.) P. B. Buchade

M.Sc., M.Phil., Ph.D.
Principal and Head
Dept. of Electronic Science,
Abasaheb Garware College,
Karve Road, Pune - 411004

Prof. (Dr.) M. L. Dongare

M.Sc., D.H.E., Ph.D.
Head, Dept. of Electronic Science,
Rayat Shikshan Sanstha's,
S. M. Joshi College,
Hadapsar, Pune - 411028

Dr. J. A. Bangali

M. Sc., M. Phil, Ph.D.
Dept. of Electronic Science,
Kaveri College of Science and Commerce,
Pune - 411038

S. R. Chaudhari

M. Sc., M.Phil.
Vice Principal and Head,
Head, Dept. of Electronic Science,
Modern College, Shivajinagar,
Pune - 411005

Price ₹ 100.00

 **NIRALI**
PRAKASHAN
ADVANCEMENT OF KNOWLEDGE

N5030



PRINCIPAL
Kannada Sangha Pune's
Kaveri College of Arts, Science & Commerce

F.Y.B.Sc : Fundamentals of Digital Electronics

First Edition : November 2019

ISBN 978-93-89686-32-6

© : Authors

The text of this publication, or any part thereof, should not be reproduced or transmitted in any form or stored in any computer storage system or device for distribution including photocopy, recording, taping or information retrieval system or reproduced on any disc, tape, perforated media or other information storage device etc., without the written permission of Authors with whom the rights are reserved. Breach of this condition is liable for legal action.

Every effort has been made to avoid errors or omissions in this publication. In spite of this, errors may have crept in. Any mistake, error or discrepancy so noted and shall be brought to our notice shall be taken care of in the next edition. It is notified that neither the publisher nor the authors or seller shall be responsible for any damage or loss of action to any one, of any kind, in any manner, therefrom.

Published By:

NIRALI PRAKASHAN

Abhyudaya Pragati, 1312, Shivaji Nagar
Off J.M. Road, PUNE - 411005
Tel - (020) 25512336/37/39, Fax - (020) 25511379
Email : niralipune@pragationline.com

Polyplate

Printed By:

RACHANA OFFSETS

S. No. 15, Arihant Marg
Sukhsagar Nagar, Katraj
Tel - (022) 2778 2011

➤ **DISTRIBUTION CENTRES**

PUNE

Nirali Prakashan : 119, Budhwar Peth, Jogeshwari Mandir Lane, Pune 411002,
(For orders within Pune) Maharashtra, Tel : (020) 2445 2044, Mobile : 9657703145
Email : niralilocal@pragationline.com

Nirali Prakashan : S. No. 28/27, Dhayari, Near Asian College Pune 411041
(For orders outside Pune) Tel : (020) 24690204; Mobile : 9657703143
Email : bookorder@pragationline.com

MUMBAI

Nirali Prakashan : 385, S.V.P. Road, Rasdhara Co-op. Hsg. Society Ltd.,
Girgaum, Mumbai 400004, Maharashtra;
Mobile : 9320129587 Tel : (022) 2385 6339 / 2386 9976,
Fax : (022) 2386 9976
Email : niralimumbai@pragationline.com

➤ **DISTRIBUTION BRANCHES**

JALGAON

Nirali Prakashan : 34, V. V. Golani Market, Navi Peth, Jalgaon 425001,
Maharashtra, Tel : (0257) 222 0395, Mob : 94234 91860;
Email : niralijalgaon@pragationline.com

KOLHAPUR

Nirali Prakashan : New Mahadvar Road, Kedar Plaza, 1st Floor Opp. IDBI Bank,
Kolhapur 416 012, Maharashtra. Mob : 9850046155;
Email : niralikolhapur@pragationline.com

NAGPUR

Nirali Prakashan : Above Maratha Mandir, Shop No. 3, First Floor,
Rani Jhanshi Square, Sitabuldi, Nagpur 440012, Maharashtra
Tel : (0712) 254 7129;
Email : niralinagpur@pragationline.com

DELHI

Nirali Prakashan : 4593/15, Basement, Agarwal Lane, Ansari Road, Daryaganj
Near Times of India Building, New Delhi 110002
Mob : 08505972553, Email : niralidelhi@pragationline.com

BENGALURU

Nirali Prakashan : Maitri Ground Floor, Jaya Apartments, No. 99, 6th Cross,
6th Main, Malleswaram, Bengaluru 560003, Karnataka;
Mob : 9449043034

Email: niralibangalore@pragationline.com

Other Branches : Hyderabad, Chennai

niralipune@pragationline.com | www.pragationline.com

Also find us on  www.facebook.com/niralibooks



PRINCIPAL

Kannada Sangha Pune's
Kaveri College of Arts, Science & Commerce

**Our Text Books for First Year B. Sc.
As per New Syllabus CBCS Pattern : Semester-II**

- **HEAT AND THERMODYNAMICS** : (Physics : Paper-I)
Dr. S. D. Aghav, V. K. Dhas, Dr. P. S. Tambade, B. M. Laware
- **ELECTRICITY AND MAGNETISM** : (Physics : Paper-II)
Dr. P. S. Tambade, B. M. Laware, Dr. S. D. Aghav, V. K. Dhas
- **INORGANIC CHEMISTRY** : (Chemistry : Paper-I)
Dr. G. S. Gugale, Dr. A. V. Nagawade, Dr. L. K. Nikam, Dr. S. S. Jadhav
- **ORGANIC CHEMISTRY** : (Chemistry : Paper-II)
Dr. A. D. Natu, Dr. V. D. Bobade, Dr. G. S. Gugale
- **FUNDAMENTALS OF DIGITAL ELECTRONICS** : (Electronics : Paper-I)
Prof. (Dr.) P. B. Buchade, Prof. (Dr.) M. L. Dongare,
Dr. J. A. Bangali, S. R. Chaudhari
- **ANALOG AND DIGITAL DEVICE APPLICATIONS** : (Electronics : Paper-II)
Prof. (Dr.) M. L. Dongare, Prof. (Dr.) P. B. Buchade,
S. R. Chaudhari, Dr. J. A. Bangali
- **PLANT LIFE AND UTILIZATION II** : (Botany : Paper-I)
Dr. K. N. Dhumal, Dr. B. P. Shinde, Dr. H. S. Patil,
Dr. K. S. Bhosale, Dr. K. N. Gaikwad
- **PRINCIPLES OF PLANT SCIENCE** : (Botany : Paper-II)
Dr. K. N. Dhumal, Dr. B. P. Shinde, Dr. H. S. Patil,
Dr. K. S. Bhosale, Dr. K. N. Gaikwad
- **ANIMAL DIVERSITY II** : (Zoology : Paper-I)
Dr. Kishore R. Pawar, Dr. Ashok A. Desai
- **CELL BIOLOGY** : (Zoology : Paper-II)
Dr. Kishore R. Pawar, Dr. Ashok A. Desai
- **BACTERIAL CELL AND BIOCHEMISTRY** : (Microbiology : Paper-I)
Dr. Pragati S. Abhyankar, Dr. Rajashree B. Patwardhan
- **MICROBIAL CULTIVATION AND GROWTH** : (Microbiology : Paper-II)
Dr. Rajashree B. Patwardhan, Dr. Pragati S. Abhyankar
- **ANALYTICAL GEOMETRY** : (Mathematics : Paper-I)
M. D. Bhagat, N. M. Phatangare, Dr. A. S. Khairnar,
R. S. Bhamare, Dr. S. G. Purane, S. D. Manjarekar
- **CALCULUS - II** : (Mathematics : Paper-II)
M. D. Bhagat, N. M. Phatangare, Dr. A. S. Khairnar,
R. S. Bhamare, Dr. S. G. Purane, S. D. Manjarekar
- **DESCRIPTIVE STATISTICS-II** : (Statistics : Paper-I)
Dr. P. G. Dixit, Dr. (Mrs.) V. R. Prayag
- **DISCRETE PROBABILITY AND PROBABILITY DISTRIBUTIONS-II** :
(Statistics : Paper-II)
Dr. (Mrs.) V. R. Prayag, Dr. P. G. Dixit, P. S. Kapre
- **PHYSICAL GEOGRAPHY-II**
Dr. Jyotiram C. More, Dr. Manojkumar P. Devne

niralipune@pragationline.com

www.pragationline.com

Also find us on



www.facebook.com/niralibooks



@nirali.prakashan



Prakash
PRINCIPAL
Kannada Sangha Pune
Kaveri College of Arts, Science & Commerce

FIRST YEAR B. Sc.

SEMESTER-II

NEW SYLLABUS

ANALOG AND DIGITAL DEVICE APPLICATIONS

CBCS
2 CREDITS

Electronics (EL-122) : Paper-II

Prof. M. L. DONGARE
Dr. J. A. BANGALI

Prof. P. B. BUCHADE
S. R. CHAUDHARI

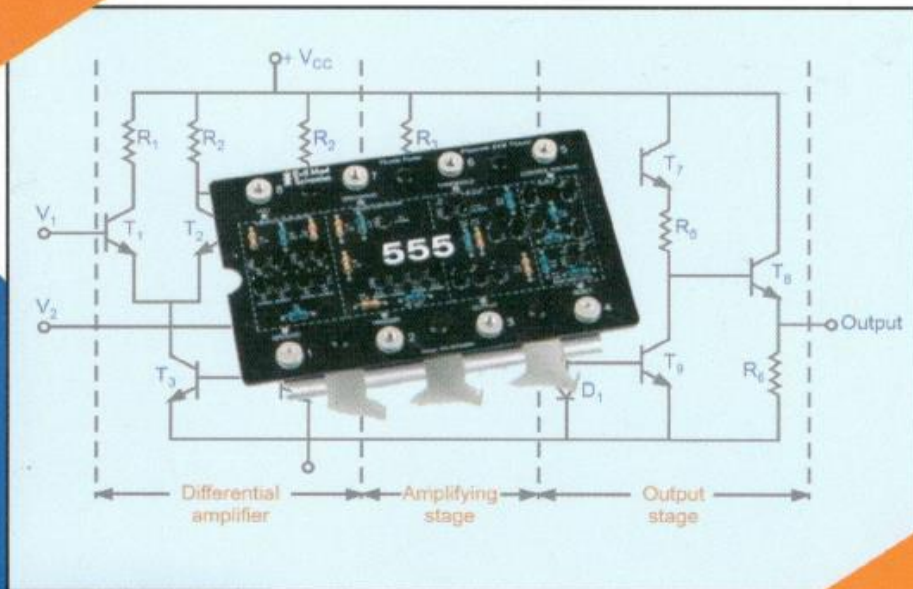

 **NIRALI**
PRAKASHAN
ADVANCEMENT OF KNOWLEDGE



PRINCIPAL
Kannada Sangha Purne
Kaveri College of Arts, Science & Commerce

Dr. Jayashri Bangali

SPPU New Syllabus

EL-122

ANALOG AND DIGITAL DEVICE APPLICATIONS

[2 Credits]

Electronic Science : Paper-II

For

First Year B.Sc. Semester-II

As Per New Syllabus of CBCS Pattern

From June - 2019

Prof. (Dr.) M. L. Dongare

M.Sc., D.H.E., Ph.D.
Head, Dept. of Electronic Science,
Rayat Shikshan Sanstha's,
S. M. Joshi College,
Hadapsar, Pune - 411028

Prof. (Dr.) P. B. Buchade

M.Sc., M.Phil., Ph.D.
Principal and Head
Dept. of Electronic Science,
Abasaheb Garware College,
Karve Road, Pune - 411004

S. R. Chaudhari

M. Sc., M.Phil.
Vice Principal and Head,
Head, Dept. of Electronic Science,
Modern College, Shivajinagar,
Pune - 411005

Dr. J. A. Bangali

M. Sc., M. Phil, Ph.D.
Dept. of Electronic Science,
Kaveri College of Science and Commerce,
Pune - 411038

Price ₹ 60.00

 **NIRALI**
PRAKASHAN
ADVANCEMENT OF KNOWLEDGE

N5031



PRINCIPAL
Kannada Sangha Pune's
Kaveri College of Arts, Science & Commerce

F.Y.B.Sc : Analog and Digital Device Applications

First Edition : October 2019

ISBN 978-93-89533-85-9

© : Authors

The text of this publication, or any part thereof, should not be reproduced or transmitted in any form or stored in any computer storage system or device for distribution including photocopy, recording, taping or information retrieval system or reproduced on any disc, tape, perforated media or other information storage device etc., without the written permission of Authors with whom the rights are reserved. Breach of this condition is liable for legal action.

Every effort has been made to avoid errors or omissions in this publication. In spite of this, errors may have crept in. Any mistake, error or discrepancy so noted and shall be brought to our notice shall be taken care of in the next edition. It is notified that neither the publisher nor the authors or seller shall be responsible for any damage or loss of action to any one, of any kind, in any manner, therefrom.

Published By:**NIRALI PRAKASHAN**

Abhyudaya Pragati, 1312, Shivaji Nagar

Off J.M. Road, PUNE - 411005

Tel - (020) 25512336/37/39, Fax - (020) 25511379

Email : niralipune@pragationline.com

Polyplate**Printed By:****RACHANA OFFSETS**

S. No. 15, Arihant Marg

Sukhsagar Nagar, Katraj

Tel - (022) 2778 2011

> DISTRIBUTION CENTRES**PUNE**

Nirali Prakashan : 119, Budhwar Peth, Jogeshwari Mandir Lane, Pune 411002,
(For orders within Pune) Maharashtra, Tel : (020) 2445 2044, Mobile : 9657703145
Email : niralilocal@pragationline.com

Nirali Prakashan : S. No. 28/27, Dhayari, Near Asian College Pune 411041
(For orders outside Pune) Tel : (020) 24690204; Mobile : 9657703143
Email : bookorder@pragationline.com

MUMBAI

Nirali Prakashan : 385, S.V.P. Road, Rasdhara Co-op. Hsg. Society Ltd.,
Girgaum, Mumbai 400004, Maharashtra;
Mobile : 9320129587 Tel : (022) 2385 6339 / 2386 9976,
Fax : (022) 2386 9976
Email : niralimumbai@pragationline.com

> DISTRIBUTION BRANCHES**JALGAON**

Nirali Prakashan : 34, V. V. Golani Market, Navi Peth, Jalgaon 425001,
Maharashtra, Tel : (0257) 222 0395, Mob : 94234 91860;
Email : niralijalgaon@pragationline.com

KOLHAPUR

Nirali Prakashan : New Mahadvar Road, Kedar Plaza, 1st Floor Opp. IDBI Bank,
Kolhapur 416 012, Maharashtra. Mob : 9850046155;
Email : niralikolhapur@pragationline.com

NAGPUR

Nirali Prakashan : Above Maratha Mandir, Shop No. 3, First Floor,
Rani Jhanshi Square, Sitabuldi, Nagpur 440012, Maharashtra
Tel : (0712) 254 7129;
Email : niralinagpur@pragationline.com

DELHI

Nirali Prakashan : 4593/15, Basement, Agarwal Lane, Ansari Road, Daryaganj
Near Times of India Building, New Delhi 110002
Mob : 08505972553, Email : niralidelhi@pragationline.com

BENGALURU

Nirali Prakashan : Maitri Ground Floor, Jaya Apartments, No. 99, 6th Cross,
6th Main, Malleswaram, Bengaluru 560003, Karnataka;
Mob : 9449043034
Email: niralibangalore@pragationline.com

Other Branches : Hyderabad, Chennainiralipune@pragationline.com | www.pragationline.comAlso find us on  www.facebook.com/niralibooks

Principal
PRINCIPAL
Kannada Sangha Pune's
Kaveri College of Arts, Science & Commerce

**Our Text Books for First Year B. Sc.
As per New Syllabus CBCS Pattern : Semester-II**

- **HEAT AND THERMODYNAMICS** : (Physics : Paper-I)
Dr. S. D. Aghav, V. K. Dhas, Dr. P. S. Tambade, B. M. Laware
- **ELECTRICITY AND MAGNETISM** : (Physics : Paper-II)
Dr. P. S. Tambade, B. M. Laware, Dr. S. D. Aghav, V. K. Dhas
- **INORGANIC CHEMISTRY** : (Chemistry : Paper-I)
Dr. G. S. Gugale, Dr. A. V. Nagawade, Dr. L. K. Nikam, Dr. S. S. Jadhav
- **ORGANIC CHEMISTRY** : (Chemistry : Paper-II)
Dr. A. D. Natu, Dr. V. D. Bobade, Dr. G. S. Gugale
- **FUNDAMENTALS OF DIGITAL ELECTRONICS** : (Electronics : Paper-I)
Prof. P. B. Buchade, Prof. M. L. Dongare, S. R. Chaudhari, Dr. J. A. Bangali
- **ANALOG AND DIGITAL DEVICE APPLICATIONS** : (Electronics : Paper-II)
Prof. M. L. Dongare, Prof. P. B. Buchade, Dr. J. A. Bangali, S. R. Chaudhari
- **PLANT LIFE AND UTILIZATION II** : (Botany : Paper-I)
Dr. K. N. Dhumal, Dr. B. P. Shinde, Dr. H. S. Patil,
Dr. K. S. Bhosale, Dr. K. N. Gaikwad
- **PRINCIPLES OF PLANT SCIENCE** : (Botany : Paper-II)
Dr. K. N. Dhumal, Dr. B. P. Shinde, Dr. H. S. Patil,
Dr. K. S. Bhosale, Dr. K. N. Gaikwad
- **ANIMAL DIVERSITY II** : (Zoology : Paper-I)
Dr. Kishore R. Pawar, Dr. Ashok A. Desai
- **CELL BIOLOGY** : (Zoology : Paper-II)
Dr. Kishore R. Pawar, Dr. Ashok A. Desai
- **BACTERIAL CELL AND BIOCHEMISTRY** : (Microbiology : Paper-I)
Dr. Pragati S. Abhyankar, Dr. Rajashree B. Patwardhan
- **MICROBIAL CULTIVATION AND GROWTH** : (Microbiology : Paper-II)
Dr. Rajashree B. Patwardhan, Dr. Pragati S. Abhyankar
- **ANALYTICAL GEOMETRY** : (Mathematics : Paper-I)
M. D. Bhagat, N. M. Phatangare, Dr. A. S. Khairnar,
R. S. Bhamare, Dr. S. G. Purane, S. D. Manjarekar
- **CALCULUS - II** : (Mathematics : Paper-II)
M. D. Bhagat, N. M. Phatangare, Dr. A. S. Khairnar,
R. S. Bhamare, Dr. S. G. Purane, S. D. Manjarekar
- **DESCRIPTIVE STATISTICS-II** : (Statistics : Paper-I)
Dr. P. G. Dixit, Dr. (Mrs.) V. R. Prayag
- **DISCRETE PROBABILITY AND PROBABILITY DISTRIBUTIONS -II** :
(Statistics : Paper-II)
Dr. (Mrs.) V. R. Prayag, Dr. P. G. Dixit, P. S. Kapre
- **PHYSICAL GEOGRAPHY-II**
Dr. Jyotiram C. More, Dr. Manojkumar P. Devne

niralipune@pragationline.com

www.pragationline.com

Also find us on



www.facebook.com/niralibooks



@nirali.prakashan



PRINCIPAL
Kannada Sangha Pune
Kaveri College of Arts, Science & Commerce

NEW
SYLLABUS

FIRST YEAR B. Sc.
COMPUTER SCIENCE SEMESTER-II

INSTRUMENTATION SYSTEMS

Electronics (ELC-121) : Paper-I

CBCS
2 CREDITS



Dr. J. A. BANGALI
Prof. P. B. BUCHADE

S. R. CHAUDHARI
Prof. M. L. DONGARE

 **NIRALI**
PRAKASHAN
ADVANCEMENT OF KNOWLEDGE



PRINCIPAL
Kannada Sangha Purne
Kaveri College of Arts, Science & Commerce

Dr. Jayashri Bangali

SPPU New Syllabus

ELC-121

INSTRUMENTATION SYSTEMS

[2 Credits]

Electronics (For Computer Science) : Paper-I
For
First Year B.Sc. Semester-II
New Syllabus as per CBCS Pattern
from June 2019

Dr. J. A. Bangali

M. Sc., M. Phil, Ph.D.
Head, Dept. of Electronic Science,
Kaveri College of Science & Commerce,
Pune - 411038

S. R. Chaudhari

M. Sc., M.Phil.
Vice Principal and Head,
Dept. of Electronic Science,
Modern College, Shivajinagar,
Pune - 411005.

Prof. (Dr.) P. B. Buchade

M.Sc., M.Phil., Ph.D.
Principal and Head,
Dept. of Electronic Science,
Abasaheb Garware College,
Karve Road, Pune - 411004.

Prof. (Dr.) M. L. Dongare

M.Sc., D.H.E., Ph.D.
Head, Dept. of Electronic Science,
Rayat Shikshan Sanstha's,
S. M. Joshi College,
Hadapsar, Pune - 411028.

Price ₹ 40.00

 **NIRALI**
PRAKASHAN
ADVANCEMENT OF KNOWLEDGE

N5062



PRINCIPAL
Kannada Sangha Pune
Kaveri College of Arts, Science & Commerce

F.Y.B.Sc : Instrumentation Systems

ISBN 978-93-89533-75-0

First Edition : October 2019

© : **Authors**

The text of this publication, or any part thereof, should not be reproduced or transmitted in any form or stored in any computer storage system or device for distribution including photocopy, recording, taping or information retrieval system or reproduced on any disc, tape, perforated media or other information storage device etc., without the written permission of Authors with whom the rights are reserved. Breach of this condition is liable for legal action.

Every effort has been made to avoid errors or omissions in this publication. In spite of this, errors may have crept in. Any mistake, error or discrepancy so noted and shall be brought to our notice shall be taken care of in the next edition. It is notified that neither the publisher nor the authors or seller shall be responsible for any damage or loss of action to any one, of any kind, in any manner, therefrom.

Published By:

NIRALI PRAKASHAN

Abhyudaya Pragati, 1312, Shivaji Nagar
Off J.M. Road, PUNE – 411005

Tel - (020) 25512336/37/39, Fax - (020) 25511379

Email : niralipune@pragationline.com

Polyplate

Printed By:

RACHANA OFFSETS

S. No. 15, Arihant Marg
Sukhsagar Nagar, Katraj

Tel - (022) 2778 2011

➤ **DISTRIBUTION CENTRES**

PUNE

Nirali Prakashan : 119, Budhwar Peth, Jogeshwari Mandir Lane, Pune 411002,
(For orders within Pune) Maharashtra, Tel : (020) 2445 2044, Mobile : 9657703145
Email : niralilocal@pragationline.com

Nirali Prakashan : S. No. 28/27, Dhayari, Near Asian College Pune 411041
(For orders outside Pune) Tel : (020) 24690204; Mobile : 9657703143
Email : bookorder@pragationline.com

MUMBAI

Nirali Prakashan : 385, S.V.P. Road, Rasdhara Co-op. Hsg. Society Ltd.,
Girgaum, Mumbai 400004, Maharashtra;
Mobile : 9320129587 Tel : (022) 2385 6339 / 2386 9976,
Fax : (022) 2386 9976
Email : niralimumbai@pragationline.com

➤ **DISTRIBUTION BRANCHES**

JALGAON

Nirali Prakashan : 34, V. V. Golani Market, Navi Peth, Jalgaon 425001,
Maharashtra, Tel : (0257) 222 0395, Mob : 94234 91860;
Email : niralijalgaon@pragationline.com

KOLHAPUR

Nirali Prakashan : New Mahadvar Road, Kedar Plaza, 1st Floor Opp. IDBI Bank,
Kolhapur 416 012, Maharashtra. Mob : 9850046155;
Email : niralikolhapur@pragationline.com

NAGPUR

Nirali Prakashan : Above Maratha Mandir, Shop No. 3, First Floor,
Rani Jhanshi Square, Sitabuldi, Nagpur 440012, Maharashtra
Tel : (0712) 254 7129;
Email : niralinagpur@pragationline.com

DELHI

Nirali Prakashan : 4593/15, Basement, Agarwal Lane, Ansari Road, Daryaganj
Near Times of India Building, New Delhi 110002
Mob : 08505972553, Email : niralidelhi@pragationline.com

BENGALURU

Nirali Prakashan : Maitri Ground Floor, Jaya Apartments, No. 99, 6th Cross,
6th Main, Malleswaram, Bengaluru 560003, Karnataka;
Mob : 9449043034
Email : niralibangalore@pragationline.com

Other Branches : Hyderabad, Chennai

niralipune@pragationline.com | www.pragationline.com

Also find us on  www.facebook.com/niralibooks



PRINCIPAL

Kannada Sangha Pune
Kaveri College of Arts, Science & Commerce

**Our Text Books for
First Year B. Sc. : Computer Science
As per New Syllabus CBCS Pattern : Semester-II**

- **Advanced 'C' Programming :** (Computer Science : Paper-I)
Dr. Ms. Manisha Bharambe, Mrs. Veena Gandhi
- **Relational Database Management Systems :**
(Computer Science : Paper-II)
Dr. Ms. Manisha Bharambe, Mrs. Veena Gandhi, Dr. A. B. Nimbalkar
- **Instrumentation Systems :** (Electronics : Paper-I)
Dr. J. A. Bangali, S. R. Chaudhari, Prof. P. B. Buchade, Prof. M. L. Dongare
- **Basics of Computer Organisation :** (Electronics : Paper-II)
S. R. Chaudhari, Dr. J. A. Bangali, Prof. M. L. Dongare, Prof. P. B. Buchade
- **Linear Algebra :** (Mathematics : Paper-I)
M. D. Bhagat, R. S. Bhamare, N. M. Phatangare,
Dr. S. G. Purane, Dr. A. S. Khairnar, S. D. Manjarekar
- **Graph Theory :** (Mathematics : Paper-II)
M. D. Bhagat, R. S. Bhamare, N. M. Phatangare,
Dr. S. G. Purane, Dr. A. S. Khairnar, S. D. Manjarekar
- **Methods of Applied Statistics :** (Statistics : Paper-I)
Dr. P. G. Dixit, Dr. (Mrs.) V. R. Prayag
- **Continuous Probability Distributions and Testing of Hypotheses :**
(Statistics : Paper-II)
Dr. (Mrs.) V. R. Prayag, Dr. P. G. Dixit

BOOKS AVAILABLE AT

PRAGATI BOOK CENTRE - Email: pbcpune@pragationline.com

- 157 Budhwar Peth, Opp. Ratan Talkies, Next To Balaji Mandir,
Pune 411002 • Mobile : 9657703148
- 676/B Budhwar Peth, Opp. Jogeshwari Mandir, **Pune 411002**
Tel : (020) 2448 7459 • **Mobile : 9657703147 / 9657703149**
- 152 Budhwar Peth, Near Jogeshwari Mandir, **Pune 411002**
Mobile : 8087881795
- 28/A Budhwar Peth, Amber Chambers, Appa Balwant Chowk,
Pune 411002 • Tel : (020) 6628 1669 • Mobile : 9657703142

PRAGATI BOOK CORNER - Email: niralimumbai@pragationline.com

- Indira Niwas, 111 - A, Bhavani Shankar Road,
Dadar (W), **Mumbai 400028. • Tel: (022) 2422 3526/6662 5254**

niralipune@pragationline.com | www.pragationline.com

niralipune@pragationline.com

www.pragationline.com

Also find us on



www.facebook.com/niralibooks



@nirali.prakashan



PRINCIPAL

Kannada Sangha Pune's
Kaveri College of Arts, Science & Commerce

NEW
SYLLABUS

FIRST YEAR B. Sc.
COMPUTER SCIENCE SEMESTER-II

BASICS OF COMPUTER ORGANIZATION

Electronics (ELC-122) : Paper-II

CBCS
2 CREDITS



S. R. CHAUDHARI
Dr. (Prof.) M. L. DONGARE

Dr. J. A. BANGALI
Dr. (Prof.) P. B. BUCHADE

 **NIRALI**
PRAKASHAN
ADVANCEMENT OF KNOWLEDGE



PRINCIPAL
Kannada Sangha Pune
Kaveri College of Arts, Science & Commerce

SPPU New Syllabus

ELC-122

BASICS OF COMPUTER ORGANIZATION

[2 Credits]

Electronics Paper-II

For

First Year B.Sc. Computer Science - Semester-II
New Syllabus as per CBCS Pattern
from June 2019

S. R. Chaudhari

M. Sc., M.Phil.
Vice Principal and Head,
Dept. of Electronic Science,
Modern College, Shivajinagar,
Pune - 411005.

Dr. J. A. Bangali

M. Sc., M. Phil, Ph.D.
Head, Dept. of Electronic Science,
Kaveri College of Science & Commerce,
Pune - 411038

Prof. (Dr.) M. L. Dongare

M.Sc., D.H.E., Ph.D.
Head, Dept. of Electronic Science,
Rayat Shikshan Sanstha's,
S. M. Joshi College,
Hadapsar, Pune - 411028.

Prof. (Dr.) P. B. Buchade

M.Sc., M.Phil., Ph.D.
Principal and Head,
Dept. of Electronic Science,
Abasaheb Garware College,
Karve Road, Pune - 411004.

Price ₹ 90.00

 **NIRALI**
PRAKASHAN
ADVANCEMENT OF KNOWLEDGE

N5063



PRINCIPAL
Kannada Sangha Pune's
Kaveri College of Arts, Science & Commerce

F.Y.B.Sc. : Basics of Computer Organisation

ISBN 978-93-89686-46-3

Third Edition : April 2022

© : Authors

The text of this publication, or any part thereof, should not be reproduced or transmitted in any form or stored in any computer storage system or device for distribution including photocopy, recording, taping or information retrieval system or reproduced on any disc, tape, perforated media or other information storage device etc., without the written permission of Authors with whom the rights are reserved. Breach of this condition is liable for legal action. Every effort has been made to avoid errors or omissions in this publication. In spite of this, errors may have crept in. Any mistake, error or discrepancy so noted and shall be brought to our notice shall be taken care of in the next edition. It is notified that neither the publisher nor the authors or seller shall be responsible for any damage or loss of action to any one, of any kind, in any manner, therefrom. The reader must cross check all the facts and contents with original Government notification or publications.

Published By :

NIRALI PRAKASHAN

Abhyudaya Pragati, 1312, Shivaji Nagar,

Off J.M. Road, Pune - 411005

Tel - (020) 25512336/37/39

Email : niralipune@pragationline.com

Polyplate

Printed By:

YOGIRAJ PRINTERS AND BINDERS

Survey No. 10/1A, Ghule Industrial Estate

Nanded Gaon Road

Nanded, Pune - 411041

DISTRIBUTION CENTRES

PUNE

Nirali Prakashan

(For orders outside Pune)

S. No. 28/27, Dhayari Narhe Road, Near Asian

College Pune 411041, Maharashtra

Tel : (020) 24690204; Mobile : 9657703143

Email : bookorder@pragationline.com

Nirali Prakashan

(For orders within Pune)

119, Budhwar Peth, Jogeshwari Mandir Lane

Pune 411002, Maharashtra

Tel : (020) 2445 2044; Mobile : 9657703145

Email : niralilocal@pragationline.com

MUMBAI

Nirali Prakashan

Rasdhara Co-op. Hsg. Society Ltd., 'D' Wing Ground Floor, 385 S.V.P. Road Girgaum, Mumbai

400004, Maharashtra Mobile : 7045821020, Tel : (022) 2385 6339 / 2386 9976

Email : niralimumbai@pragationline.com

DISTRIBUTION BRANCHES

DELHI

Nirali Prakashan

Room No. 2 Ground Floor

4575/15 Omkar Tower,

Agarwal Road Darya Ganj,

New Delhi 110002

Mobile : 9555778814/

9818561840

Email : delhi@niralibooks.com

BENGALURU

Nirali Prakashan

Maitri Ground Floor, Jaya

Apartments, No. 99, 6th Cross,

6th Main, Malleswaram,

Bengaluru 560003 Karnataka;

Mob : 9686821074

Email :

bengaluru@niralibooks.com

NAGPUR

Nirali Prakashan

Above Maratha Mandir,

Shop No. 3, First Floor, Rani

Jhanshi Square, Sitabuldi

Nagpur 440012 (MAH)

Tel : (0712) 254 7129

Email :

nagpur@niralibooks.com

KOLHAPUR

Nirali Prakashan

438/2, Bhosale Plaza, Ground

Floor, Khasbag, Opp.

Balgopal Talim,

Kolhapur 416 012,

Maharashtra

Mob : 9850046155

Email :

kolhapur@niralibooks.com

JALGAON

Nirali Prakashan

34, V. V. Golani Market, Navi

Peth, Jalgaon 425001,

Maharashtra

Tel : (0257) 222 0395

Mob : 94234 91860

Email :

jalgaon@niralibooks.com

SOLAPUR

Nirali Prakashan

R-158/2, Avanti Nagar,

Near Golden Gate, Pune

Naka Chowk Solapur

413001, Maharashtra

Mobile 9890918687

Email :

solapur@niralibooks.com

marketing@pragationline.com | www.pragationline.com

Also find us on  www.facebook.com/niralibooks



PRINCIPAL

Kannada Sangha Pune
Kaveri College of Arts, Science & Commerce

**Our Text Books for
First Year B. Sc. : Computer Science
As per New Syllabus CBCS Pattern : Semester-II**

- **Advanced 'C' Programming** : (Computer Science : Paper-I)
Dr. Ms. Manisha Bharambe, Mrs. Veena Gandhi
- **Relational Database Management Systems** :
(Computer Science : Paper-II)
Dr. Ms. Manisha Bharambe, Mrs. Veena Gandhi, Dr. A. B. Nimbalkar
- **Instrumentation Systems** : (Electronics : Paper-I)
Dr. J. A. Bangali, S. R. Chaudhari, Prof. P. B. Buchade, Prof. M. L. Dongare
- **Basics of Computer Organization** : (Electronics : Paper-II)
S. R. Chaudhari, Dr. J. A. Bangali, Prof. M. L. Dongare, Prof. P. B. Buchade
- **Linear Algebra** : (Mathematics : Paper-I)
M. D. Bhagat, R. S. Bhamare, N. M. Phatangare,
Dr. S. G. Purane, Dr. A. S. Khairnar, S. D. Manjarekar
- **Graph Theory** : (Mathematics : Paper-II)
M. D. Bhagat, R. S. Bhamare, N. M. Phatangare,
Dr. S. G. Purane, Dr. A. S. Khairnar, S. D. Manjarekar
- **Methods of Applied Statistics** : (Statistics : Paper-I)
Dr. P. G. Dixit, Dr. (Mrs.) V. R. Prayag
- **Continuous Probability Distributions and Testing of Hypotheses** :
(Statistics : Paper-II)
Dr. (Mrs.) V. R. Prayag, Dr. P. G. Dixit

BOOKS AVAILABLE AT

PRAGATI BOOK CENTER - Email: pbcpune@pragationline.com

- 157 Budhwar Peth, Opp. Ratan Talkies, Next To Balaji Mandir,
Pune 411002 • Mobile : 9657703148
- 676/B Budhwar Peth, Opp. Jogeshwari Mandir, **Pune 411002**
Tel : (020) 2448 7459 • **Mobile : 9657703147 / 9657703149**
- 152 Budhwar Peth, Near Jogeshwari Mandir, **Pune 411002**
Mobile : 8087881795

PRAGATI BOOK CORNER - Email: niralimumbai@pragationline.com

- Apurva Building, Shop No. 1, Bhavani Shankar Road,
Opp. Shardashram Society, Dadar (W), Mumbai 400028.
Tel: (022) 2422 3526/6662 5254 • **Mobile : 9819935759**

niralipune@pragationline.com | www.pragationline.com

niralipune@pragationline.com

www.pragationline.com

Also find us on



www.facebook.com/niralibooks



[@nirali.prakashan](https://www.instagram.com/nirali.prakashan)



PRINCIPAL
Kannada Sangha Pune
Kaveri College of Arts, Science & Commerce

Read to lead



Business ography

KCASC LIBRARY



S08636



THAKUR PUBLICATION PVT. LTD.
PUNE

Dr. Shweta Bapat
Priyanka Sachin Jadhav



[Signature]
PRINCIPAL

Kannada Sangha Pune's
Kaveri College of Arts, Science & Commerce



BUSINESS DEMOGRAPHY

BBA, SEMESTER -I

According to the new syllabus of 'Savitribai Phule Pune University'

Dr. Shweta Bapat

Ph.D (CSR), MMS (HR), PGDBM, B.Com

Head of Department

Kaveri College of Science and Commerce, Pune

**KAVERI COLLEGE OF ARTS, SCIENCE
& COMMERCE, PUNE-38.
LIBRARY**

Priyanka S. Jadhav

MBA (HR), LLB, B.Sc

Assistant Professor

Suryadatta College of Management, Information Research and Technology, Pune

Books are Available for Online Purchase at: tppl.org.in

**KAVERI COLLEGE OF ARTS,
SCIENCE & COMMERCE
LIBRARY**

Accession No.: 8536

Date: 26 AUG 2019



THAKUR PUBLICATION PVT. LTD., PUNE

* Lucknow * Meerut * Hyderabad * Kerala * Jaipur * Chennai * Rohtak *
* Jalandhar * Ahmedabad * Bengaluru * Bhubaneswar * Bhopal * Kerala * Kolkata*



PRINCIPAL
Kannada Sangha Pune's
Kaveri College of Arts, Science & Commerce

Business Demography

Edition 2013

Revised Edition 2019

Copyright © All Rights Reserved

This book is sole subject to the condition that it shall not, by way of trade or otherwise, be lent, resold, hired out, otherwise circulated without the publisher's prior written consent, in any form of binding or cover, other than that in which it is published and without including a similar condition. This condition being imposed on the subsequent purchaser without limiting the rights under copyright reserved above, no part of this publication may be reproduced, stored in a retrieval system, transmitted in any form or by any means (electronic, mechanical, photocopying, recording or otherwise), without the prior written permission of both the copyright owner and the below mentioned publisher of this book.

Published by :

Thakur Publication Pvt. Ltd.

C.T.S. No-635, Flat No-T-7, Third Floor, Bhudhwar Peth, ABC Market,
Pune-411002. Mob.: 09373086387, 9326863355, 9335318517, 9235318594/22.

Thakur Publication Pvt. Ltd., Head (Regd.) Office:

Head Office: House No.645B/187 Abhishekpuram, 60 Feet Road,
Jankipuram, Near- Ramkishor Convent Inter College, Lucknow-226021
Ph. 9235318596/22/17,9260903794

Website: www.tppl.org.in

Email: thakurpublication@gmail.com

Retailers/Distributors

PUNE

1. Adarsh Book Agency, 629, Budhwar Peth, Appa Balwant Chowk, Near Ratan Cinema Basement Pune. Ph-020-24497435.
2. Aryan Books, 680, Budhwar Peth., ABC Chowk, Near Jageshwar Temple, Opp. Venus Traders Mob.: 09822978095, 09552292929.
3. Goel Book Agency, 31, Budhwar Peth, Next to Jogeshwari Temple. Pune-411002. Ph. 020-24453267, 9890938870.
4. Jagruti Book Agency, 128, Budhwar Peth Sakshatkar, Opp. Jogeshwari Mandir, Pune. Mob. 09850039320, 02024436334.
5. Jai Mata Ji Book Collection, Aakurdi Main Road, Near Maruti Temple, Pune Mob-9921618171.
6. Laxmi Book Depot Rambag Colony, Dhavalgiri Apt., Near M.L.T. College, Pune. Mob.: 8888307035, 9527705325.
7. OM Book Stall, 629, Budhwar Peth., Ratan Talkies, Kakade Arcade, Ground Floor, Shop No. 48 12 A, Pune-411002. Ph.: 020-24435333, 020-244553331.
8. Patel Traders, 676/A, Budhwar Peth, Opp. Jogeshwari Mandir, Pune - 411002. Mob.: 94220145533, 020-24457322, .
9. Pradeep Book Depot, Shop No. 31, Indraprastha Complex, Manjari Phate, Hadapsar, Pune-411028. Ph. 020-26990101, 26993647, 9604010202, 99850699947.
10. Pragati Book Centre, 157, Budhwar Peth, Opp. Ratan Talkies, Pune-411002. Ph. 020-24458887, 66022707, 9657703148.
11. Sakalp Stationers, Canal Road, Baramati. Mob.: 09765018999, 09209800339.
12. Samarpanam Book Seller Pimpri, Sant Tukaram Nagar, Opp. Ganesh Mandir, Mhada Complex. Ph.: 9922307131.
13. Samarpanam Book Seller, Shop No. 12, 'S' bldg., Dhruv Darshan Cmplx, Near P.C.C.O.E., Akurdi. Mob. 09823665769.

14. Saraswati Granth Bhandar, 671, Budhwar Peth, Appa Balwant Chowk, Pune. Mob. 09423580797, 09822679099.
15. Vikas Book & Stationers, 151, Budhwar Peth, Appa Balwani Chowk, Near Jogeshwari Mandir, Pune. Ph. 020-24468737, 9921331187.
16. New Laxmi Book Depot, Nhrhe, Shop No.-5, Shree Samarth Residency, Manaji Nagar, Narhe, Mob.: 9850852240/8668484759.

NASHIK

17. Anmol Book Service, 5, Munanda Market, M.G Road, Nashik Ph. 0253-2505501, 2339401, 9325362413.
18. Anmol Pustakalaya, Saubhagya Chambers, Bytco Point, Nashik Road, Pune. Ph. 0253-2461603, 2461003, 9822306289.
19. Rahul Book Centre, Tilak Path, Opp. Sarvajani Vachanalaya, Near Bank of Maharashtra, Nashik-1. Ph. 020-2599608, 2502168, 9881845022.
20. Maharashtra Pustak Bhandar, Nasik, 475, Opp. Shani Mandir, Ravi War Peth, Nasik, Mob.: 9860221213

AHMED NAGAR

21. Shreepad Granth Bhandar, Shani Chowk, Ahmed Nagar. Ph. 0241-2347307, 9922664979.

JALGAON

22. Prashant Book House, 17, KDM Shopping Centre, Opp. SBI Jalgaon, Jalgaon-425001. Ph. 0257-2235520, 9421636460.
23. Yash Books, 28/A, Amber Chamber, Near Appa Balwant Chowk, Bhudhwar Peth, Pune Maharashtra-411002. Mob. 8698939892, 9923699235.
24. Suyog Enterprises, Shop No. 7, Dhurav Darshan Behind Pimpri Chinchawad, Polytechnic Akurdi-Pune- 411044. Mb. 9822398034

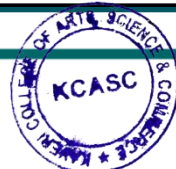

PRINCIPAL

Kannada Sangha Pune's
Kaveri College of Arts, Science & Commerce

About the Book

This book of 'Business Demography' is designed to cover basic concepts of demographics, population and environment. The book primarily serves as a text for management students of University of Pune. This book would help to understand the concepts relating to business demographics, aspects of demography in business, population and population growth, population as resource, urbanisation, etc. A variety of tools such as tables, figures and index are used to provide more adapting view to students and make the subject easier for them.

About the Author



Dr. Shweta Bapat is PGDBM, MMS (HR) and is presently working as Head, Department of Management in Kaveri College of Science and Commerce, Pune. She has 7 years of corporate experience and 11 years of teaching experience to the courses like MPM, MMM, MBS BBA (IB), B.Com and BBA. She has completed her Ph.D in Corporate Social Responsibility from Pune University. Her areas of interest are Principles of Management, Business Demography & Environmental Studies, Business Organisation and Systems, Human Resource Management, Industrial Relations, Labour law, Research Methodology, Business Ethics, Entrepreneurship Development, Event Management, etc. She has presented several research papers at State, National & International level conferences and some of them got published under ISBN number. She has also written articles for Sakal, Jobs Supplement. She is also president of Pune base non-profit organisation 'Business Ethics Foundation'.



Mrs. Priyanka Sachin Jadhav is Assistant Professor in Suryadatta College of Management, Information Research & Technology, Pune. She is MBA and is having 8 years of experience both in academic as well as in corporate sector and she is also completed LL.B. Her areas of interest are Principles of Management, Business Organisation and Systems, Business Demography & Environmental Studies, Human Resource Management, Industrial Relations, Business Protocol & Cross Cultural Communication, HRM Principles & Practices, Business Strategies, Training & Development, Business Law, International Business Law, Business Regulatory Framework etc.

Savitribal Phule Pune University, BBA/BBA(IB)-1st Semester

Subjects	Authors
Principles of Management	Mr. D. S. Jadhavkar, Ms. Shikha Vijaykumar Kulkarni, Mrs. Manisha S. Patil (Patil)
Business Communication Skills	Mrs. Ananda Ghosh, Mr. Prashant Kulkarni
Business Accounting	Dr. Santosh, Mr. Manish Thakur
Business Economics-Theory	Mr. Manish Late Tadar, Mr. Kalpana Vaidya
Business Mathematics	Mrs. Pooja Agreel
Business Demography	Dr. Shweta Bapat, Mrs. Priyanka Sachin Jadhav



Scan QR Code



Also Book Available on:
 amazon
 kindle tppl.org.in
www.questonpaper.org.in

ISBN: 978-81-89294-38-0



PRINCIPAL
Kannada Sangha Pune's
Kaveri College of Arts, Science & Commerce

CONSUMER PROTECTION AND BUSINESS ETHICS - I

F. Y. B. Com. (Sem. - I)

- Prof. Dr. Arun Gaikwad
- Prof. Dr. Shweta Bapat
- Prof. Dr. Shivlal. N. Nanaware

Choice Based Credit System (CBCS)

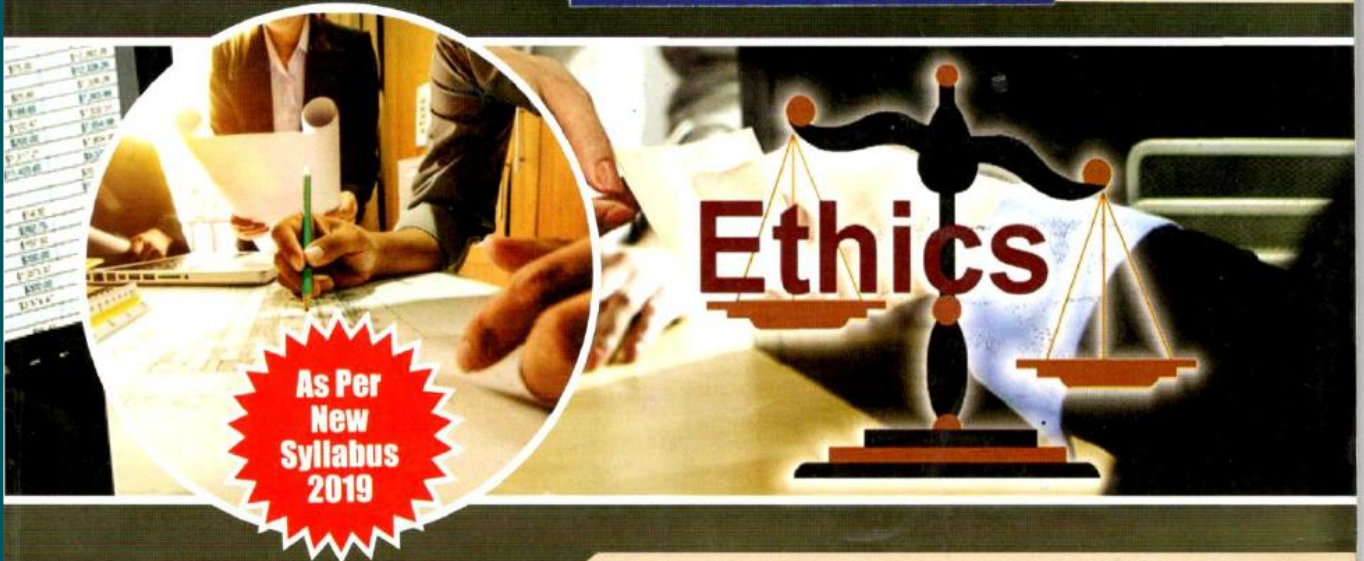

SUCCESS PUBLICATIONS



Principal
PRINCIPAL
Kannada Sangha Pune
Kavari College of Arts, Science & Commerce

This Text Book is useful for Savitribai Phule Pune University and other Universities of Maharashtra as well as Competitive Exams.

Consumer Protection and Business Ethics - I

F.Y.B.Com. (Sem. - I)

Prof. Dr. Arun Gaikwad

(M. Com., G.D.C. & A, Ph. D)

Sangamner Nagarpalika Arts, D.J. Malpani Commerce and
B.N. Sarada Science College, Sangamner, Ahemdagar.

Prof. Dr S N. Nanaware

(M.Com., M.Phil., D.T.L., Ph.D)

Professor Ramakrishna More Arts, Commerce & Science College, Pune.

Prof. Dr. Shweta Bapat

(P.G.D.B.M., M.M.S. (HR), Ph.D)

Kaveri College of Arts, Science and Commerce, Pune.

2019

Price : 115/-



SUCCESS PUBLICATIONS



[Signature]
PRINCIPAL
Kannada Sangha Pune
Kaveri College of Arts, Science & Commerce

Published by
Dr. Rajesh M. Patne
Success Publications
Radha Krishna Apartment, 535, Shaniwar Peth,
Appa Balwant Chowk, Opp. Prabhat Talkies, Pune - 411 030.
Ph. 24434662. Mobile: 9325315464.

Copyrights
With the Publishers

Printed at
Success Publications
S.No. 30/27, Laxmi Industrial Estate, Near Prabhat News Paper,
Dhayari, Pune-41. Mobile : 9028211751

Edition
2019

Edited By
Mr. Vaimik Gaikwad

Typesetting, Layout
Mrs. Pradnya Kale

Cover Designing
Mrs. Aparna Mali

ISBN NO. – 978-93-89066-09-8

No part of this book may be reproduced or copied in any form or by any means [graphic, electronic or mechanical, including photocopying, recording, taping, or information retrieval systems] or reproduced on any disc, tape, perforated media or other information storage device, etc., without the written permission of the publishers.

Every effort has been made to avoid errors or omissions in this book. In spite of this errors may creep in. Any mistake, error or discrepancy noted may be brought to our Notice which shall be taken care of in the next edition. It is Notified that publisher shall not be responsible for any damage or loss of action to anyone of any kind in any manner, therefrom. It is suggested to all the readers, always refer original references wherever necessary.



4

Read to Lead

SPPU

B.Com Computer Concepts and Application-I 1st Sem

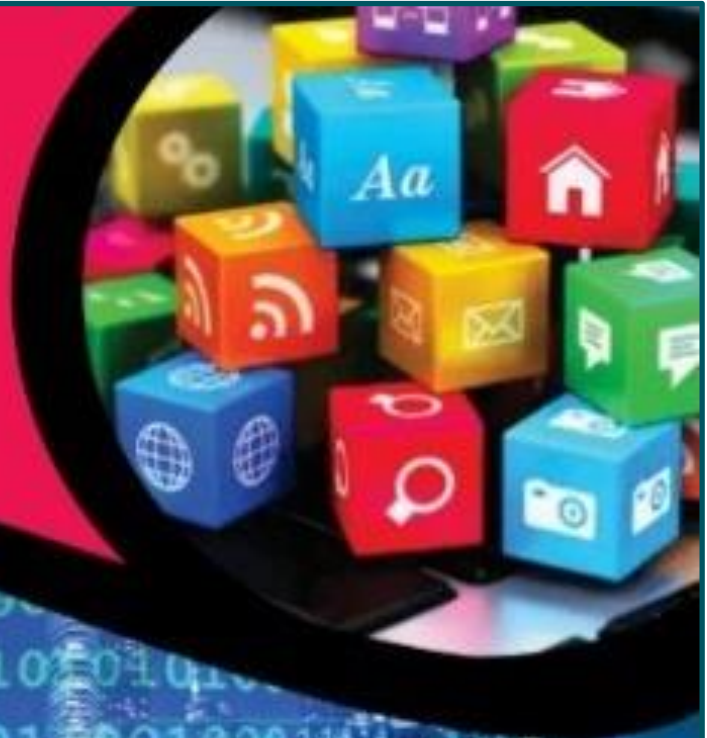

Computer Concepts and Application-I

Pratima Bhalekar
Yogeshwari Dannak



THAKUR PUBLICATION PVT. LTD.
PUNE



Pratima
PRINCIPAL
Kannada Sangha Pune
Kavari College of Arts, Science & Commerce

COMPUTER CONCEPTS & APPLICATION-I

B.COM, SEMESTER - I

According to the new syllabus of 'Savitribai Phule Pune University', Pune

Prof. Pratima Bhalekar

M.Sc.(Comp. Sci.), B.sc (Comp. Sci.)

Assistant Professor

Ashoka Center for business and Computer Studies, Nashik

Yogeshwari Dannak

M.Sc.(Software Engineering), B.Sc. (C.S)

Associate Professor

Kaveri College of Arts, Science & Commerce, Pune

Books are Available for Online Purchase at: tppl.org.in

Download old Question Papers From: www.questionpaper.org.in



THAKUR PUBLICATION PVT. LTD., PUNE

* Lucknow * Meerut * Hyderabad * Kerala * Jaipur * Chennai * Rohtak *
* Jalandhar * Ahmedabad * Bengaluru * Bhubaneswar * Bhopal * Kerala * Kolkata*



[Signature]
PRINCIPAL

Kannada Sangha, Pune

Kaveri College of Arts, Science & Commerce

About the Book

The book **Computer Concepts and Application-1** has been designed strictly in accordance with the latest syllabus presented by **Savitribai Phule Pune University, Pune** for **B.Com First Semester**.

The material in this book is designed to provide maximum flexibility of use for teachers and students alike. It includes the basic concepts of computer, database, data communication and system security with aims at sharpening the skills of the students. Key features of this book are:

- Simplicity of the book is its ethos and clarity is its strength.
- Emphasis on presentation of variety of topics.
- Language is consistent, and easy for students to follow.

About the Author



Prof. Pratima Bhalekar is working as Assistant Professor in Ashoka Center for Business and Computer Studies, Nashik. She is having 11 years of teaching experience and 1 year of software industry experience. She has done **B.Sc.(Computer Science), M.Sc.(Computer Science)**. She has taught diverse set of subjects like Internet Programming, Web Development, PHP, Data Structure, System Programming and Operating Systems, Java script, C, C++ etc. She has also presented papers at various seminars/conferences and workshop at National and International Levels.



Ms. Yogeshwari Dannak has very extensive teaching experience in computer science. She has over 9 years of teaching experience with acclaimed academics and expertise in various computer science subjects. She has been part of various educational committees which work for betterment of students. Presently she is working with **Kaveri College of Arts Science & Commerce, Pune**.

Savitribai Phule Pune University, B.Com-1st Semester

Subjects	Author
Financial Accounting-I	Ms. Sneha G. Burgul
Business Economics(Micro)-I	(Prof.) Dr. Samadhan Borse, Prof. Piyush Dixit
Business Mathematics and Statistics-I	Dr. Mangesh P. Waghmare, Prof. Ravikiran Pratul Kakade
Computer Concepts and Application-I	Prof. Pratima Bhalekar, Ms. Yogeshwari Dannak
Optional Group-A	Optional Group-B
Organisation Skill Development	Essentials of E-Commerce
Banking and Finance	Marketing & Salesmanship
Managerial Economics	Business Environment & Entrepreneurship

MRP: ₹170

THAKUR PUBLICATION PVT. LTD.
PUNE
www.tppl.org.in

ISBN:978-93-89294-64-4



Principal
PRINCIPAL
Kannada Sangha Pune
Kaveri College of Arts, Science & Commerce